

RZUT PARTERU

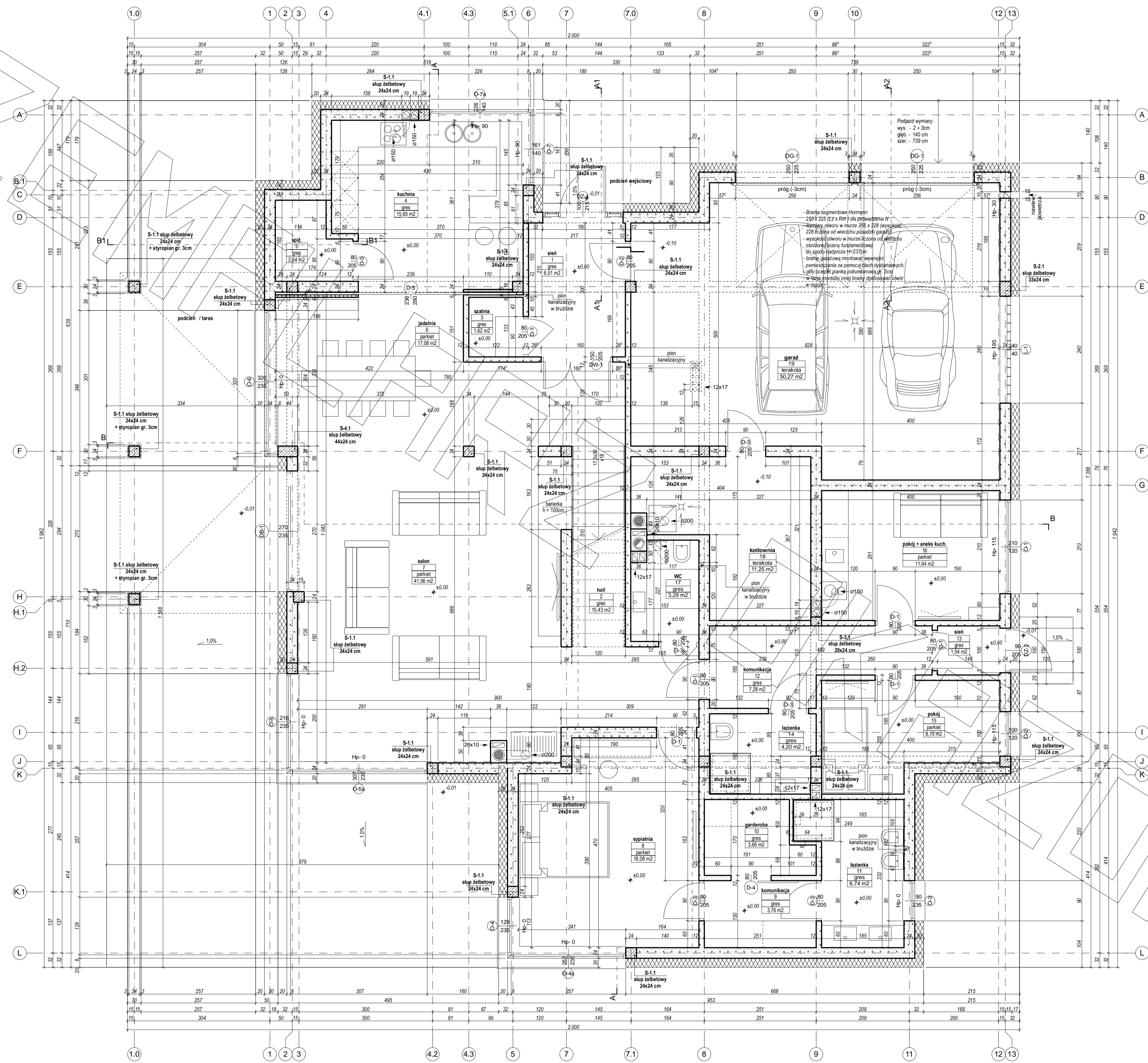

RZUT PIĘTRA

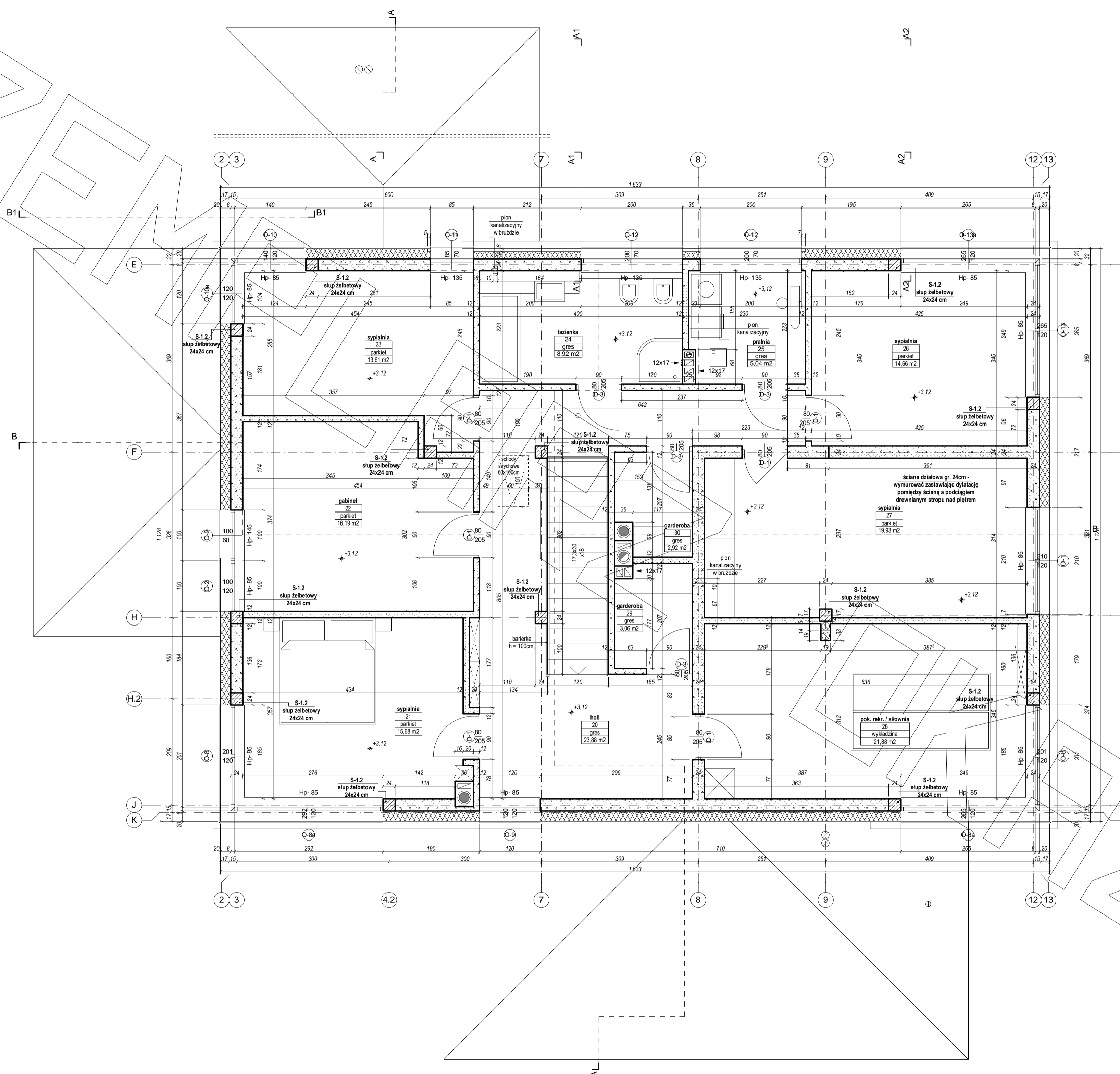

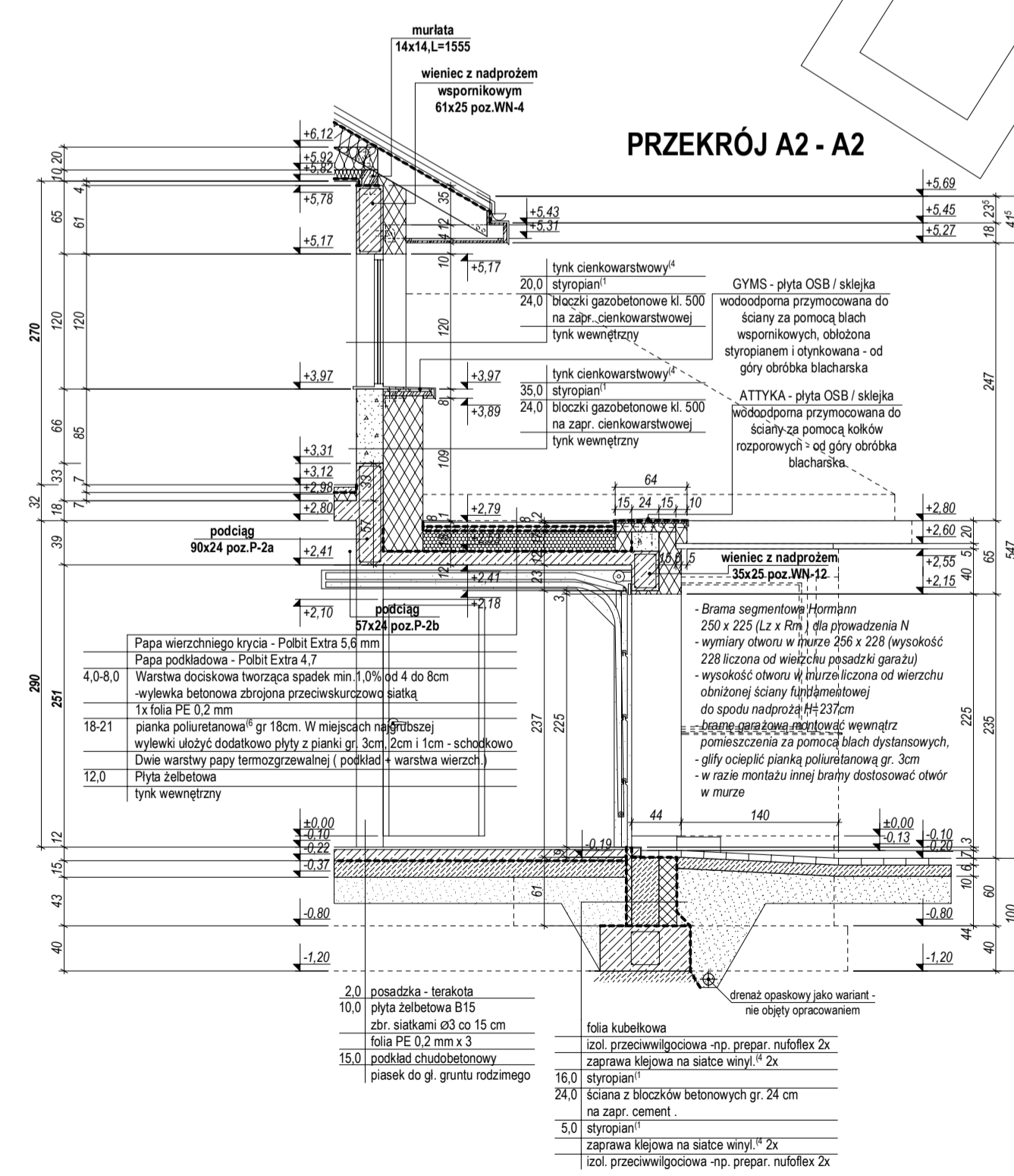
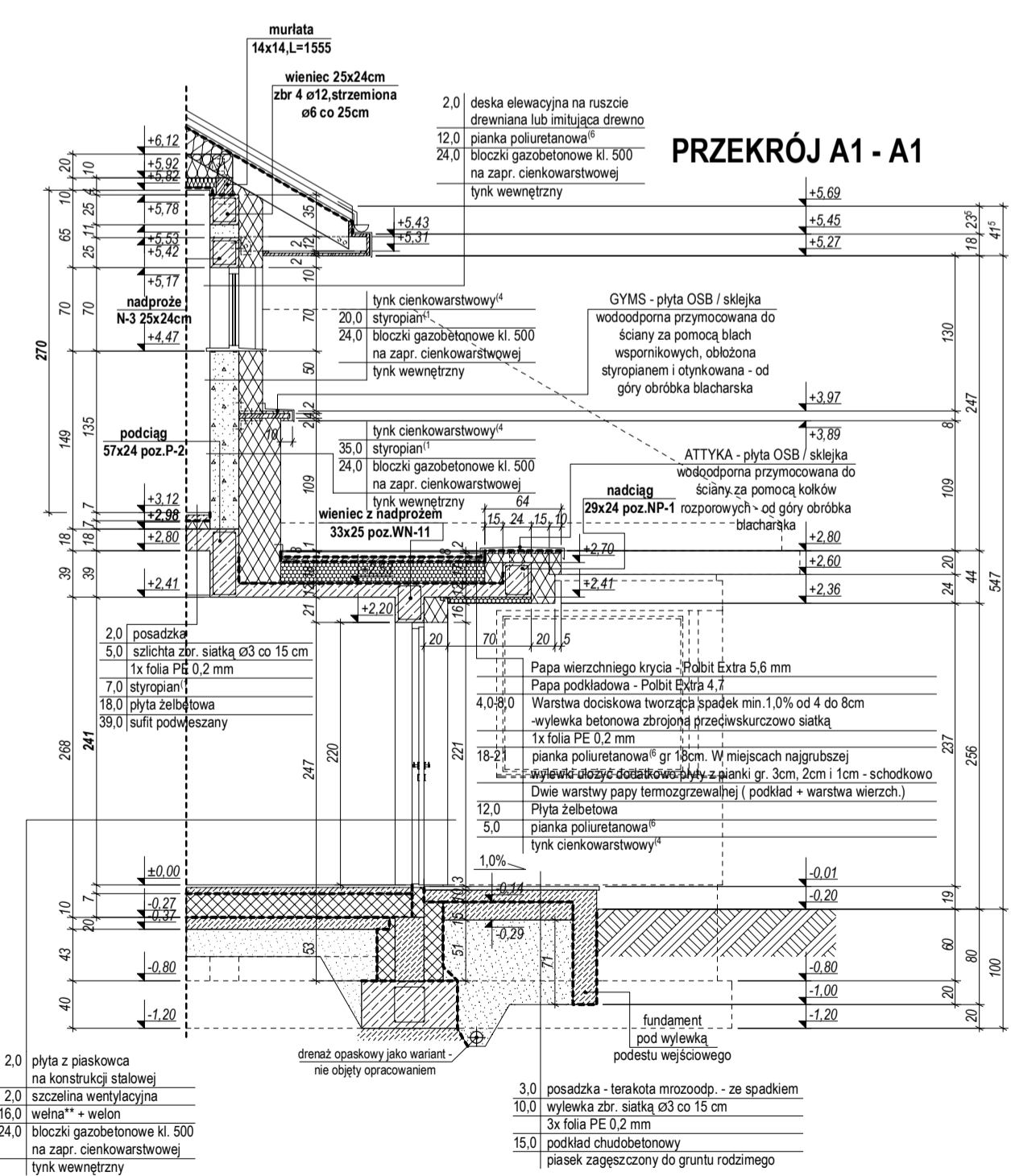
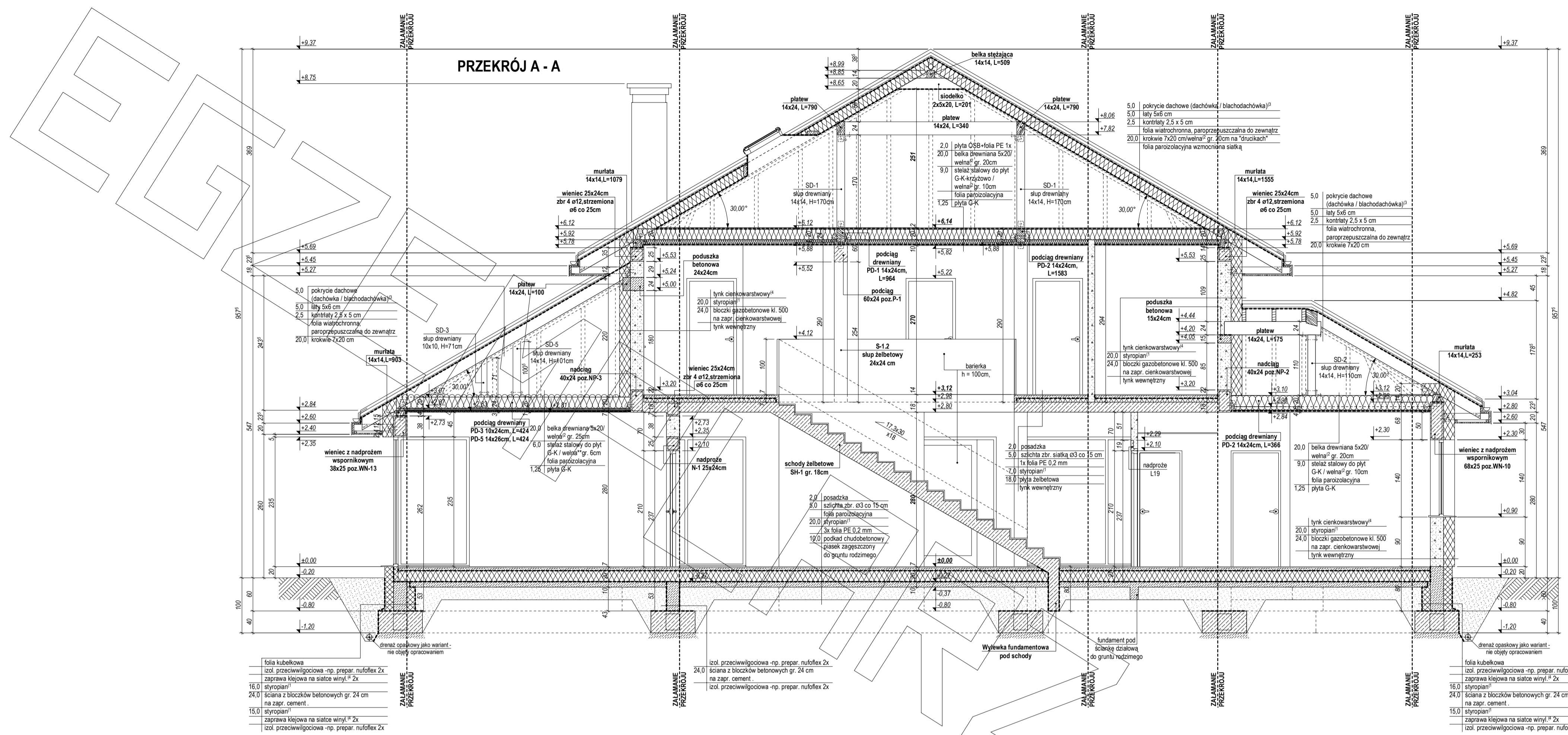

PRZEKRÓJ

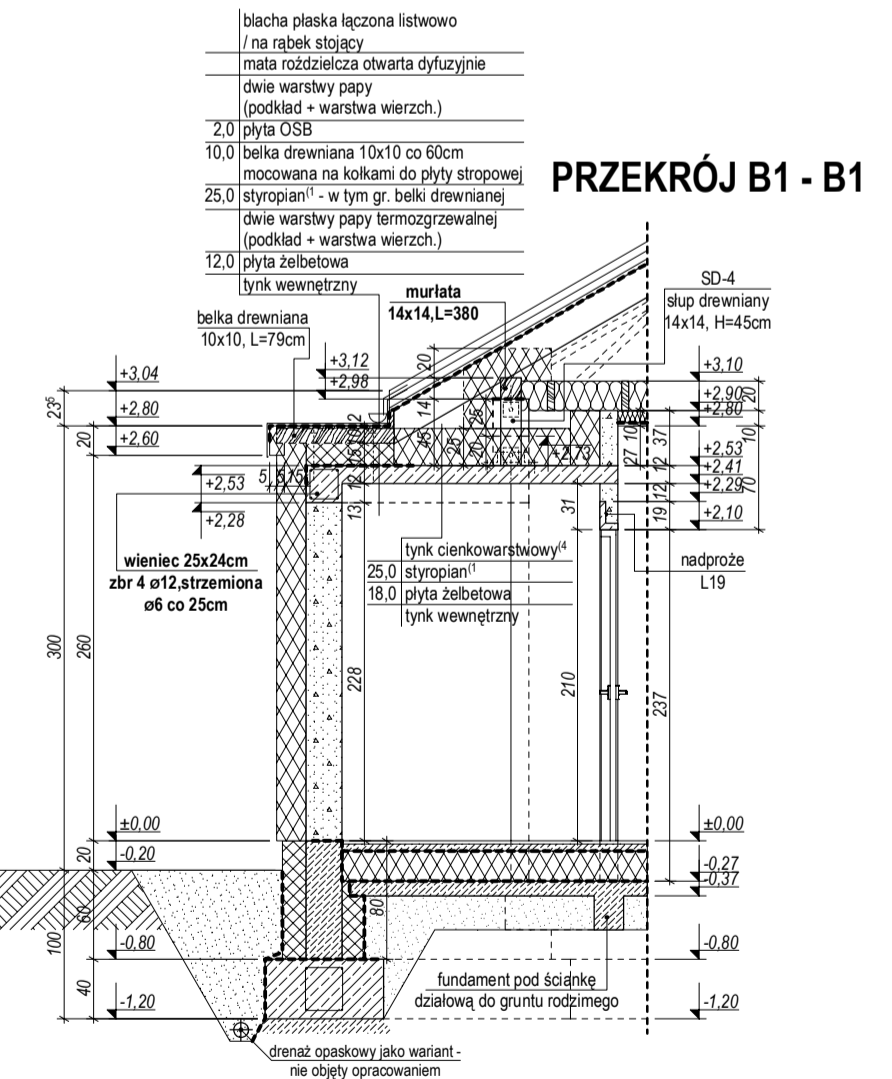
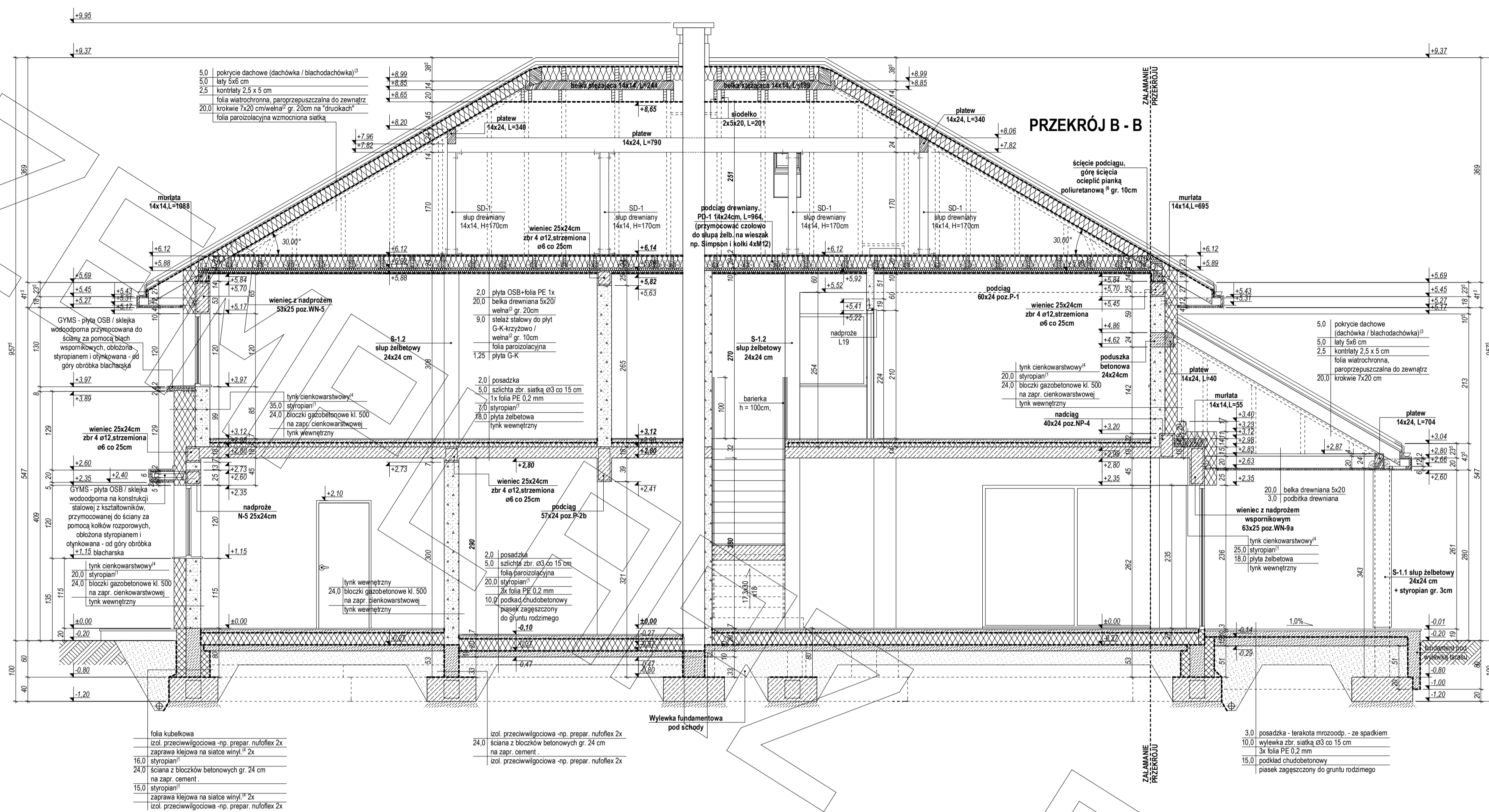

ELEWACJE

